

Capacitance Diaphragm Gauge

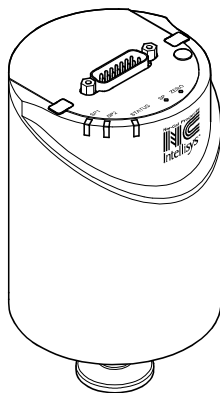



160 °C heated



Operating Manual
Incl. EC Declaration of Conformity

Product Identification

In all communications with Nor-Cal Products, please specify the information given on the product nameplate. For convenient reference copy that information into the space provided below.

Nor-Cal Products Inc., Yreka, CA 96097, USA			
P/N: _____			
S/N: _____			
Range: _____			
_____V _____W; LPS			

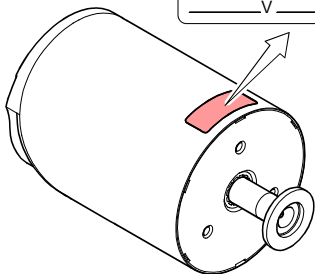

Validity

This document applies to products with the following part numbers:

Part number	Flange	Torr
CDG160-T31	½" tube	10 ⁻¹ ... 1000 (F.S.)
CDG160-T31-NW1	DN 16 ISO-KF	
CDG160-T31-CF	DN 16 CF-R	
CDG160-T31-VCR	8 VCR®	
CDG160-T21	½" tube	10 ⁻² ... 100 (F.S.)
CDG160-T21-NW1	DN 16 ISO-KF	
CDG160-T21-CF	DN 16 CF-R	
CDG160-T21-VCR	8 VCR®	
CDG160-T12	½" tube	2x10 ⁻³ ... 20 (F.S.)
CDG160-T12-NW1	DN 16 ISO-KF	
CDG160-T12-CF	DN 16 CF-R	
CDG160-T12-VCR	8 VCR®	
CDG160-T11	½" tube	10 ⁻³ ... 10 (F.S.)
CDG160-T11-NW1	DN 16 ISO-KF	
CDG160-T11-CF	DN 16 CF-R	
CDG160-T11-VCR	8 VCR®	
CDG160-T02	½" tube	2x10 ⁻⁴ ... 2 (F.S.)
CDG160-T02-NW1	DN 16 ISO-KF	
CDG160-T02-CF	DN 16 CF-R	
CDG160-T02-VCR	8 VCR®	
CDG160-T01	½" tube	10 ⁻⁴ ... 1 (F.S.)
CDG160-T01-NW1	DN 16 ISO-KF	
CDG160-T01-CF	DN 16 CF-R	
CDG160-T01-VCR	8 VCR®	

The part number (P/N) can be taken from the product nameplate.

If not indicated otherwise in the legends, the illustrations in this document correspond to Capacitance Diaphragm Gauges with the DN 16 ISO-KF vacuum connection. They apply to gauges with other vacuum connections by analogy.

We reserve the right to make technical changes without prior notice.

All dimensions in mm.

Intended Use

The temperature controlled Capacitance Diaphragm Gauges are intended for absolute pressure measurement of gases in their respective pressure ranges (→  3).

The gauges can be operated in connection with a Nor-Cal Vacuum Gauge Controller or another appropriate controller.

Functional Principle

A ceramic diaphragm is deflected by pressure. The deflection is measured capacitively and converted into an analog linear output signal by the digital electronics.

The output signal is independent of the gas type.

Very accurate pressure measurement is achieved by heating the sensor to a constant temperature of 160°C which results in a compensation of changes in the ambient conditions and a reduced deposition of process products and by-products in process applications. An integrated baffle protects the sensor against coating.

Trademark

VCR[®] Swagelok Marketing Co.

Patents

EP 1070239, 1040333

US Patents 6528008, 6591687, 7107855, 7140085

Scope of Delivery

1x Capacitance Diaphragm Gauge

1x Insulation shell

1x Pin



1x Calibration Test Report

1x Operating Manual

Contents

Product Identification	2
Validity	3
Intended Use	4
Functional Principle	4
Trademark	4
Patents	5
Scope of Delivery	5
1 Safety	8
1.1 Symbols Used	8
1.2 Personnel Qualifications	8
1.3 General Safety Instructions	9
1.4 Liability and Warranty	9
2 Technical Data	10
3 Installation	15
3.1 Vacuum Connection	15
3.2 Power Connection	19
4 Operation	22
4.1 Status Indication	22
4.2 Zeroing the Gauge	23
4.2.1 <ZERO> Adjustment	23
4.2.2 <ZERO> Adjustment with Ramp Function	25
4.3 Switching Functions	27
4.3.1 Adjusting the Setpoints	28
4.4 Activating the Factory Setting (Factory Reset)	30
5 Deinstallation	31
5.1 Power Connection	31
5.2 Vacuum connection	31
6 Maintenance, Repair	34
7 Returning the Product	34
8 Disposal	35

Further Information	36
ETL Certification	36
Declaration of Contamination	37
EC Declaration of Conformity	39

For cross-references within this document, the symbol (→  XY) is used, for cross-references to further documents, listed under "Further Information", the symbol (→  [Z]).

1 Safety

1.1 Symbols Used



DANGER

Information on preventing any kind of physical injury.



WARNING

Information on preventing extensive equipment and environmental damage.



Caution

Information on correct handling or use. Disregard can lead to malfunctions or minor equipment damage.



Notice

1.2 Personnel Qualifications



Skilled personnel

All work described in this document may only be carried out by persons who have suitable technical training and the necessary experience or who have been instructed by the end-user of the product.

1.3 General Safety Instructions

- Adhere to the applicable regulations and take the necessary precautions for the process media used.
Consider possible reactions with the product materials.
- Adhere to the applicable regulations and take the necessary precautions for all work you are going to do and consider the safety instructions in this document.
- Before beginning to work, find out whether any vacuum components are contaminated. Adhere to the relevant regulations and take the necessary precautions when handling contaminated parts.

Communicate the safety instructions to all other users.

1.4 Liability and Warranty

Nor-Cal Products assumes no liability and the warranty becomes null and void if the end-user or third parties

- disregard the information in this document
- use the product in a non-conforming manner
- make any kind of interventions (modifications, alterations etc.) on the product
- use the product with accessories not listed in the product documentation.

The end-user assumes the responsibility in conjunction with the process media used.

Gauge failures due to contamination are not covered by the warranty.

2 Technical Data

Measurement range	→ "Validity"
Accuracy ¹⁾	0.4% of reading
Temperature effect on zero	0.005% F.S./ °C
Temperature effect on span	0.02% of reading / °C
Resolution	0.003% F.S.
Gas type dependence	none
<hr/>	
Output signal analog (measurement signal)	
Measurement range	0 ... +10 V
Voltage range	-5 ... +10.24 V (limited to +10.24 V)
Relationship voltage-pressure	linear
Output impedance	0 Ω (short-circuit proof)
Loaded impedance	>10 kΩ
Response time ²⁾	30 ms
<hr/>	
Identification	
Resistance R _{Ident}	13.2 kΩ referenced to
Voltage	supply common ≤5 V
<hr/>	
Switching functions	SP1, SP2
Setting range	0 ... 99% F.S. (0 ... 9.9 V)
Hysteresis	1% F.S.
Relay contact	30 VDC/ ≤0.5 ADC floating (n.o.)
closed	p ≤ p _{SP} (LED lit solid)
<hr/>	

¹⁾ Non-linearity, hysteresis, repeatability in the calibrated range at 25 °C ambient operating temperature without temperature effects after operation of 2 h.

²⁾ Increase 10 ... 90 % F.S.

open	$p \geq p_{SP}$ (LED off)
Switching time	≤ 50 ms
<hr/>	
Status relay	
closed	measurement mode warning
open	no supply voltage warming up error
<hr/>	
RS232C interface	
Transmission rate	9600 baud
Data format	binary 8 data bits one stop bit no parity bit no handshake → "Power Connection"

For further information on the RS232C interface →  [1].

Supply

DANGER



The gauge may only be connected to power supplies, instruments or control devices that conform to the requirements of a grounded protective extra-low voltage (SELV) and limited power source (LPS), Class 2. The connection to the gauge has to be fused.

Supply voltage at the gauge	Class 2 / LPS +21 ... +30 VDC or ±15 V (±5%)
Ripple	≤1 V _{pp}
Power consumption while being heated	≤18 W
at operating	≤12 W

The gauge is protected against reverse polarity of the supply voltage and overload.

Electrical connection	15-pin D-Sub, male
Sensor cable	15-pin plus shielding
Cable length	
Supply voltage 24 V	≤ 5 m (0.14 mm ² /conductor) ≤ 8 m (0.25 mm ² /conductor)
Supply voltage 30 V	≤ 9 m (0.14 mm ² /conductor) ≤17 m (0.25 mm ² /conductor)

For longer cables, larger conductor cross-sections are required ($R_{\text{cable}} \leq 1.0 \Omega$).

Grounding concept	→ "Power Connection"
-------------------	----------------------

Materials exposed to vacuum	ceramics (Al ₂ O ₃ ≥99.5%), stainless steel AISI 316L, nickel, glass solder
Internal volume	≤4.2 cm ³
Admissible pressure (absolute)	
1000 Torr (F.S.)	3 bar
1 ... 100 Torr (F.S.)	2 bar
Burst pressure (absolute)	6 bar

Admissible temperatures

Storage	-40 °C ... +65 °C
Operation	+10 °C ... +50 °C
Bakeout	≤200 °C at the flange

Relative humidity

≤80% at temperatures
 ≤+31 °C, decreasing to 50%
 at +40°C

Use

indoors only, altitude up to
 2000 m NN

Degree of protection

IP 40

Dimensions [mm]

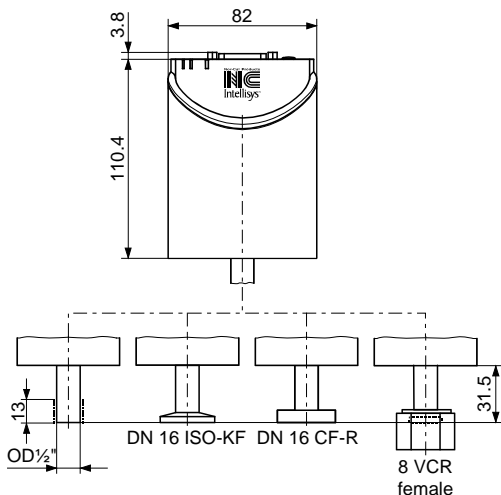

Weight

837 ... 897 g

Analog Measurement Signal vs. Pressure

Pressure p

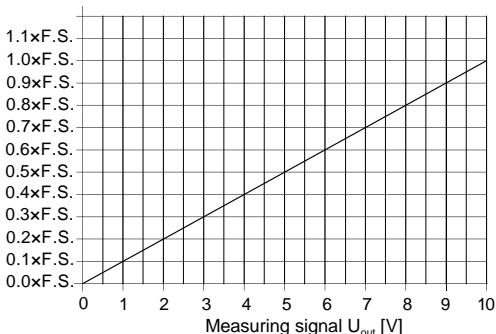

$$p = (U_{\text{out}} / 10 \text{ V}) \times p (\text{F.S.})$$

Conversion Torr \leftrightarrow Pascal

	Torr	mbar ³⁾	Pa ³⁾
c	1.00	1013.25 / 760 = 1.3332...	101325 / 760 = 133.3224...

Example: Gauge with 10 Torr F.S.
Measurement signal $U_{\text{out}} = 6 \text{ V}$

$$\begin{aligned} p &= (6 \text{ V} / 10 \text{ V}) \times 10 \text{ Torr} \\ &= 0.6 \times 10 \text{ Torr} = \mathbf{6 \text{ Torr}} \end{aligned}$$

³⁾ Source: NPL (National Physical Laboratory)
Guide to the Measurement of Pressure and Vacuum, ISBN 0904457x / 1998

3 Installation



WARNING



WARNING: fragile components

The ceramic sensor may be damaged by impacts. Do not drop the product and prevent shocks and impacts.

3.1 Vacuum Connection



DANGER



DANGER: overpressure in the vacuum system >1 bar

Injury caused by released parts and harm caused by escaping process gases can result if clamps are opened while the vacuum system is pressurized. Do not open any clamps while the vacuum system is pressurized. Use the type clamps which are suited to overpressure.

DANGER



DANGER: overpressure in the vacuum system >2.5 bar

KF flange connections with elastomer seals (e.g. O-rings) cannot withstand such pressures. Process media can thus leak and possibly damage your health. Use O-rings provided with an outer centering ring.

 **DANGER**

DANGER: protective ground

Products that are not correctly connected to ground can be extremely hazardous in the event of a fault.

Electrically connect the gauge to the grounded vacuum chamber. This connection must conform to the requirements of a protective connection according to EN 61010:

- CF and VCR flanges fulfill this requirement.
- For gauges with a KF flange, use a conductive metallic clamping ring.
- For gauges with a ½" tube, take appropriate measures to fulfill this requirement.

**Caution**

Caution: vacuum component

Dirt and damages impair the function of the vacuum component.

When handling vacuum components, take appropriate measures to ensure cleanliness and prevent damages.

**Caution**

Caution: dirt sensitive area

Touching the product or parts thereof with bare hands increases the desorption rate.

Always wear clean, lint-free gloves and use clean tools when working in this area.

-  Mount the gauge so that no vibrations occur. The gauge may be mounted in any orientation. To keep condensates and particles from getting into the measuring chamber preferably choose a horizontal to upright position. If adjustment should be possible after the gauge has been installed, be sure to install it so that the buttons can be accessed with a pin (→ 23).

- 1** Remove the protective lid and connect the product to the vacuum system.

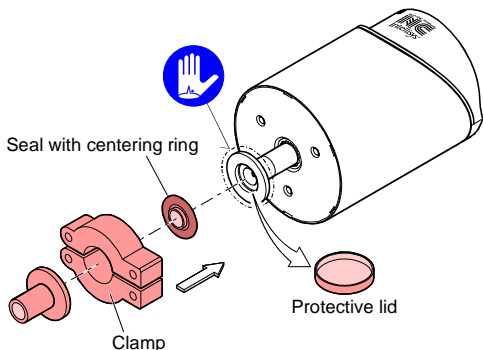

Keep the protective lid.

- 2** Mount the insulation shell.

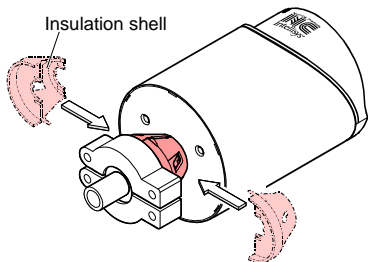

3.2 Power Connection



Make sure the vacuum connection is properly made (→  15).



DANGER



The gauge may only be connected to power supplies, instruments or control devices that conform to the requirements of a grounded protective extra-low voltage (SELV) and limited power source (LPS), Class 2. The connection to the gauge has to be fused.



Ground loops, differences of potential, or EMC problems may affect the measurement signal. For optimum signal quality, please do observe the following notes:

- Connect the cable shield to ground on one side via the chassis ground. Do not connect the other side of the shield.
- Connect the supply common with protective ground directly at the power supply.
- Use differential measurement input (signal common and supply common conducted separately).
- Potential difference between supply common and housing ≤ 18 V (overvoltage protection).

- 1** If no sensor cable is available, make one according to the following diagram (cable length and conductor cross-sections → 12).

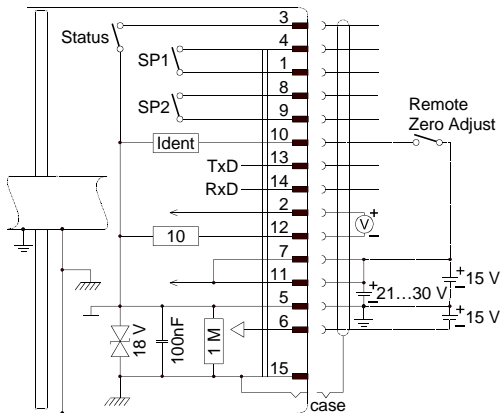

Electrical connection

Pin 1, 4	Relay SP1, closing contact
Pin 2	Signal output (measurement signal) or thresholds SP1/2
Pin 3	Status
Pin 5	Supply common
Pin 6	Supply (-15 V)
Pin 7, 11	Supply (+21 ... +30 V or +15 V)
Pin 8, 9	Relay SP2, closing contact
Pin 10	Gauge identification or Remote Zero Adjust
Pin 12	Signal common
Pin 13	RS232, TxD
Pin 14	RS232, RxD
Pin 15	Housing (Chassis Ground)
case	Connector case

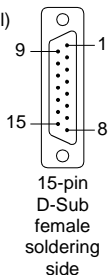

- 2** Connect the sensor cable to the gauge and secure it using the lock screws.

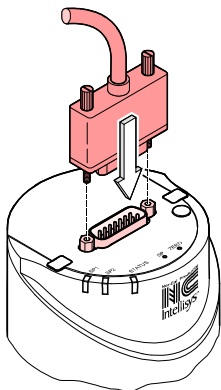

- 3** Connect the sensor cable to the controller.

4 Operation

Put the gauge into operation. If you are using a Nor-Cal controller, define the measurement range.

A warm-up time of at least 2 hours should be allowed; for precise pressure measurements a warm-up time of at least 4 hours is required.

4.1 Status Indication

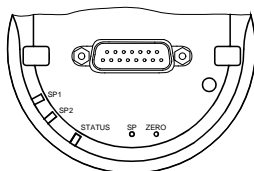

LED	LED status	Meaning
<STATUS>	off	no supply voltage
	lit solid green	measurement mode
	blinking green	warning
	short blinks long blinks	warming up
<SP1>	lit solid red	error
	lit solid green	$p \leq$ setpoint 1
	blinking green	waiting for setpoint 1 input
<SP2>	off	$p >$ setpoint 1
	lit solid green	$p \leq$ setpoint 2
	blinking green	waiting for setpoint 2 input
	off	$p >$ setpoint 2

4.2 Zeroing the Gauge

The gauge is factory calibrated while "standing upright" (→ "Calibration Test Report").



We recommend performing a zero adjustment, when the gauge is operated for the first time.

Due to long time operation or contamination, a zero drift could occur and zero adjustment may become necessary.

For adjusting the zero, operate the gauge under the same constant ambient conditions and in the same mounting orientation as normally.

The output signal (measuring signal) is depending on the mounting orientation. The signal difference between the vertical and horizontal mounting orientation is:

F.S.	$\Delta U / 90^\circ$
1000 Torr	$\approx 2 \text{ mV}$
100 Torr	$\approx 10 \text{ mV}$
10 Torr	$\approx 50 \text{ mV}$
1 Torr	$\approx 300 \text{ mV}$



If the gauge is operated via a controller, the zero of the whole measuring system has to be adjusted on the controller: first, adjust the zero of the gauge and then, the zero of the controller.

4.2.1 <ZERO> Adjustment



The zero can be adjusted via

- the <ZERO> button on the gauge,
- the digital input "Remote Zero" (briefly apply the supply voltage (+21 ... +30 V) to pin 10),
- the RS232C interface (→  [1]),
- a Nor-Cal Vacuum Gauge Controller.



While the gauge is being heated and/or under atmospheric pressure, the zeroing function is locked in order for operating errors to be prevented.

- 1 Evacuate the gauge to a pressure according to the table below:

F.S.	Recommended final pressure for zero adjustment
1000 Torr	$<5 \times 10^{-2}$ Torr
100 Torr	$<5 \times 10^{-3}$ Torr
20 Torr	$<1 \times 10^{-3}$ Torr
10 Torr	$<5 \times 10^{-4}$ Torr
2 Torr	$<1 \times 10^{-4}$ Torr
1 Torr	$<5 \times 10^{-5}$ Torr

If the final pressure is too high for zero adjustment ($>25\%$ of the F.S.), the zero cannot be reached and the <STATUS> LED blinks green. If this is the case, activate the factory setting and adjust the zero again (\rightarrow 30).

- 2 Operate the gauge for at least 2 hours under constant ambient conditions (until the signal is stable).
- 3 Briefly press the <ZERO> button with a pin (max. $\varnothing 1.1$ mm). The zero adjustment runs automatically. The <STATUS> LED blinks until the adjustment (duration ≤ 8 s) is completed.

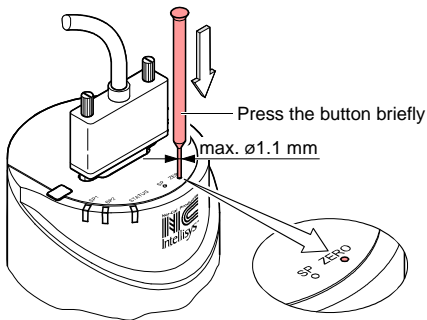



After zero adjustment, the gauge automatically returns to the measurement mode.

The <STATUS> LED blinks green if

- the signal output is negative (< -20 mV) when the final pressure has been attained
- the zero adjustment has failed.

4.2.2 <ZERO> Adjustment with Ramp Function

The ramp function allows to adjust the zero at a known reference pressure within the measurement range of the gauge.

It also permits to adjust an offset of the characteristic curve in order to

- compensate for the offset of the measuring system or
- obtain a slightly positive zero for a 0 ... 10 V AD converter.

The offset should not exceed 2% of the F.S. (+200 mV). At a higher positive offset, the upper limit of the measurement range is exceeded.



Zero adjustment using the ramp function can be performed via

- the <ZERO> button on the gauge,
- the RS232C interface (\rightarrow  [1]).



Recommended procedure for adjusting the offset of a measuring system: \rightarrow Notice  23.

1

Operate the gauge for at least 2 hours under constant ambient conditions (until the signal is stable).

2

Push the <ZERO> button with a pin (max. $\varnothing 1.1$ mm) and keep it depressed. The <STATUS> LED starts blinking. After 5 s, the zero adjustment value, starting at the current output value, keeps continually changing (ramp) until the button is released or until the setting limit (max. 25% F.S.) is reached. The corresponding output signal is delayed by about 1 s.

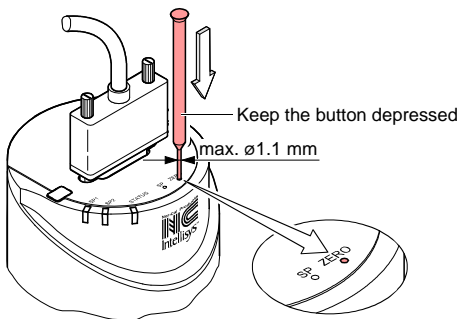

3 Push the <ZERO> button again:

Fine adjustment
 within 0...3 s:

the zero adjustment value changes
 by one unit (push <ZERO> button in
 intervals of 1 s)

Change of direction
 within 3...5 s:

the zero adjustment changes its
 direction (the blinking frequency of
 the <STATUS> LED changes
 briefly)



If the <ZERO> button is released for more than 5 s, the gauge returns to the measurement mode.

The <STATUS> LED blinks green if the signal output is negative (< -20 mV).

4.3 Switching Functions

The two switching functions can be set to any pressure within the measurement range of the gauge (→ 14).

The current setpoint setting

- is output at the D-Sub connector instead of the measurement signal (→ 20) and can be measured with a voltmeter after the <SP> button is pressed, or
- can be read/written via the RS232C interface.

If the pressure is lower than the setpoint, the corresponding LED (<SP1> or <SP2>) is lit solid and the corresponding relay (→ 20) is energized.

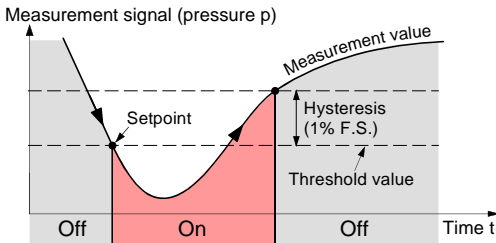

4.3.1 Adjusting the Setpoints



The setpoints can be adjusted via

- the buttons on the gauge,
- the RS232C interface (→  [1]).



DANGER



DANGER: malfunction

If processes are controlled via the signal output, keep in mind that by pushing the <SP> button the measurement signal is suppressed and the corresponding threshold value is output instead. This can cause malfunctions.

Push the <SP> button only if you are sure that no damages can arise from a malfunction.

Adjusting Setpoint <1>

1

Push the <SP> button with a pin (max. $\varnothing 1.1$ mm). The gauge changes to the switching function mode and outputs the current threshold value at the measurement value output for about 10 s (LED <1> blinks).

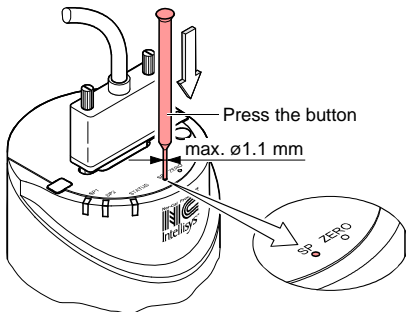

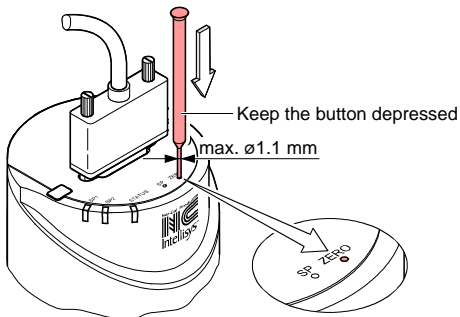

- 2** For changing the threshold value, push the <ZERO> button and keep it depressed. The threshold keeps changing from the current value (ramp) until the button is released or until the limit of the setting range is reached.



- 3** Push the <ZERO> button again:

Fine adjustment within 0...3 s:	the zero adjustment value changes by one unit
Change of direction within 3...5 s:	the zero adjustment changes its direction (the blinking frequency of the <STATUS> LED changes briefly)

-  If the <ZERO> button is released for more than 5 s, the gauge returns the measurement mode.
-  The upper threshold is automatically set 1% F.S. above the lower one (hysteresis).

Adjusting Setpoint <2>

Push the <SP> button twice (the LED <2> blinks). The adjustment procedure is the same as for setpoint <1>.

4.4 Activating the Factory Setting (Factory Reset)

All user defined parameters (e.g. zero, filter) are restored to their default values.



Loading of the default parameters is irreversible.

Loading the default parameters:

- ① Put the gauge out of operation.
- ② Keep the <ZERO> button depressed for at least 5 s while the gauge is being put into operation (Power ON).

5 Deinstallation

Preconditions:

- Vacuum system vented
- Vacuum system cooled to $<50\text{ }^{\circ}\text{C}$

5.1 Power Connection

- 1 Put the gauge out of operation.
- 2 Unfasten the lock screws and disconnect the sensor cable.

5.2 Vacuum connection



DANGER



DANGER: hot surface
 Touching the hot surface ($>50\text{ }^{\circ}\text{C}$) can cause burns.
 Put the product out of operation and allow it to cool down.



WARNING



WARNING: fragile components
 The ceramic sensor may be damaged by impacts.
 Do not drop the product and prevent shocks and impacts.

 **DANGER**



DANGER: contaminated parts

Contaminated parts can be detrimental to health and environment.

Before beginning to work, find out whether any parts are contaminated. Adhere to the relevant regulations and take the necessary precautions when handling contaminated parts.



Caution



Caution: vacuum component

Dirt and damages impair the function of the vacuum component.

When handling vacuum components, take appropriate measures to ensure cleanliness and prevent damages.



Caution



Caution: dirt sensitive area

Touching the product or parts thereof with bare hands increases the desorption rate.

Always wear clean, lint-free gloves and use clean tools when working in this area.

- 1 Remove the insulation shell.

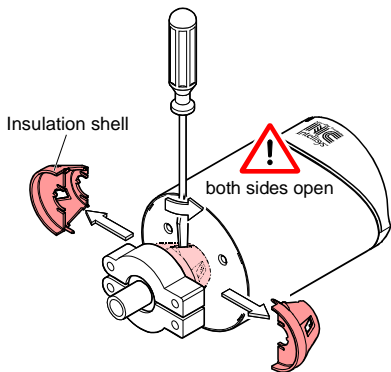

- 2 Remove the gauge from the vacuum system and install the protective lid.

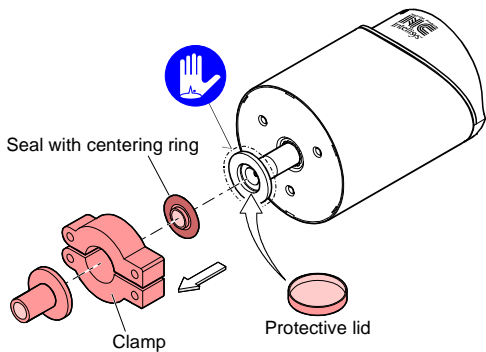

6 Maintenance, Repair

Under clean operating conditions, the product requires no maintenance.



Gauge failures due to contamination are not covered by the warranty.

We recommend checking the zero at regular intervals (→  23).

Nor-Cal assumes no liability and the warranty becomes null and void if any repair work is carried out by the end-user or third parties.

7 Returning the Product



WARNING



WARNING: forwarding contaminated products
 Contaminated products (e.g. radioactive, toxic, caustic or microbiological hazard) can be detrimental to health and environment.

Products returned to Nor-Cal should preferably be free of harmful substances. Adhere to the forwarding regulations of all involved countries and forwarding companies and enclose a duly completed declaration of contamination.

Products that are not clearly declared as "free of harmful substances" are decontaminated at the expense of the customer.

Products not accompanied by a duly completed declaration of contamination are returned to the sender at his own expense.

8 Disposal

DANGER



DANGER: contaminated parts

Contaminated parts can be detrimental to health and environment.

Before beginning to work, find out whether any parts are contaminated. Adhere to the relevant regulations and take the necessary precautions when handling contaminated parts.

WARNING



WARNING: substances detrimental to the environment

Products or parts thereof (mechanical and electric components, operating fluids etc.) can be detrimental to the environment.

Dispose of such substances in accordance with the relevant local regulations.

Separating the components

After disassembling the product, separate its components according to the following criteria:

- Contaminated components
 Contaminated components (radioactive, toxic, caustic or biological hazard etc.) must be decontaminated in accordance with the relevant national regulations, separated according to their materials, and disposed of.
- Other components
 Such components must be separated according to their materials and recycled.

Further Information

- [1] www.n-c.com
Communication Protocol
RS232C Interface
tnra49e1
Nor-Cal Products, Inc., Yreka, CA 96097, USA

ETL Certification



ETL LISTED

The product Capacitance Diaphragm Gauge complies with the requirements of the following Standards:
UL 61010-1, Issued: 2004/07/12 Ed: 2
Rev: 2005/07/22
CAN/CSA C22.2#61010-1,
Issued: 2004/07/12

Declaration of Contamination

The service, repair, and/or disposal of vacuum equipment and components will only be carried out if a correctly completed declaration has been submitted. Non-completion will result in delay.

This declaration may only be completed (in block letters) and signed by authorized and qualified staff.

1 Description of product
 Type _____
 Part number _____
 Serial number _____

2 Reason for return

3 Operating fluid(s) used (Must be drained before shipping.)

4 Used in copper process
 no yes → Seal product in plastic bag and mark it with a corresponding label.

5 Process related contamination of product:

toxic	no <input type="checkbox"/> 1)	yes <input type="checkbox"/>
caustic	no <input type="checkbox"/> 1)	yes <input type="checkbox"/> 2)
biological hazard	no <input type="checkbox"/>	yes <input type="checkbox"/> 2)
explosive	no <input type="checkbox"/>	yes <input type="checkbox"/> 2)
radioactive	no <input type="checkbox"/>	yes <input type="checkbox"/> 2)
other harmful substances	no <input type="checkbox"/> 1)	yes <input type="checkbox"/>

1) or not containing any amount of hazardous residues that exceed the permissible exposure limits

2) Products thus contaminated will not be accepted without written evidence of decontamination.



The product is free of any substances which are damaging to health. yes

6 Harmful substances, gases and/or by-products
 Please list all substances, gases, and by-products which the product may have come into contact with:

Trade/product name	Chemical name (or symbol)	Precautions associated with substance	Action if human contact

7 Legally binding declaration:
 We hereby declare that the information on this form is complete and accurate and that we will assume any further costs that may arise. The contaminated product will be dispatched in accordance with the applicable regulations.

Organization/company _____
 Address _____ Post code, place _____
 Phone _____ Fax _____
 Email _____
 Name _____

Date and legally binding signature _____ Company stamp _____

This form can be downloaded from our website.

Copies:
 Original for addressee - 1 copy for accompanying documents - 1 copy for file of sender

EC Declaration of Conformity



We, Nor-Cal Products, hereby declare that the equipment mentioned below complies with the provisions of the Directive relating to electrical equipment designed for use within certain voltage limits 2006/95/EC and the Directive relating to electromagnetic compatibility 2004/108/EC.

Capacitance Diaphragm Gauge 160 °C heated

Standards

Harmonized and international/national standards and specifications:

- EN 61000-3-2:2006 (EMC: limits for harmonic current emissions)
- EN 61000-3-3:1995 + A1:2001 + A2:2005 (EMC: limitation of voltage changes, voltage fluctuations and flicker)
- EN 61000-6-2:2005 (EMC: generic immunity standard)
- EN 61000-6-3:2007 (EMC: generic emission standard)
- EN 61010-1:2001 (Safety requirements for electrical equipment for measurement, control and laboratory use)

Signatures

Nor-Cal Products, Inc., Yreka, CA 96097, USA

5 January 2010

5 January 2010

Per M. Cederstav
 Director of Product Marketing

Cheri Clemons
 Quality Manager



Notes

Nor-Cal Products



1967 South Oregon St.
Yreka, CA 96097, USA
Tel: 800-824-4166
Fax: 530-842-9130

Original: English tna53e1 (2009-11)



tna53e1

www.n-c.com